



Dental Handpiece Maintenance Device

Lubrina 2

INSTRUCTIONS FOR USE

Thank you for purchasing the Lubrina 2, dental handpiece maintenance device.
For optimum safety and performance as well as to avoid causing harm to people, read this manual thoroughly before using the device and pay close attention to warnings and cautions.
Keep this manual in a readily accessible place for quick and easy reference.

Trademarks (™) and Registered Trademarks (®):
The names of companies, services, etc. used in this manual are either trademarks or registered trademarks.

© 2019 J. MORITA MFG. CORP.

Table of Contents

1 Accident Prevention	4
1.1 Customers	4
1.2 Dealers	4
1.3 Preventing Accidents	4
1.4 Disclaimers	4
2 Precautions	5
3 Intended Use and Usage Flow	6
4 Components	7
5 Parts Identification and Function	8
5.1 Parts Identification	8
5.2 Operation Panel: Name and Function of Switches and Indicator Lamps	9
5.2.1 Recommended Mode	9
6 Setup	11
6.1 Main Unit	11
6.1.1 Installation	11
6.1.2 Air Tube	12
6.1.3 Power Cord	13
6.2 Spray Cans	14
6.2.1 Spray Stands	15
6.2.2 Spray Cans	16
6.2.3 Spray Stand Adjustment	17
6.3 Couplings	18
6.4 Oil Absorbent Sheet	19
6.5 Oil Collection Tray and Oil Absorbent Pad	19
6.6 Door Oil Absorbent Sheet and Front Door Sheet Stopper	20
7 Usage	21
7.1 Operating, Transport and Storage Environments	21
7.2 Maintenance Categories	21
7.3 Basic Operation	22
7.3.1 Turning Power On/Off	22
7.3.2 Chuck Lubrication	22
7.3.3 Handpiece Body Lubrication	23
7.3.4 Switching Maintenance Mode	26
7.4 Other Maintenance Modes	27
7.4.1 Air Blow Mode	27
7.4.2 Flushing Mode	27

8 Cleaning the Device and Replacing Parts	29
8.1 Daily Cleaning.....	29
8.1.1 Main Unit.....	29
8.1.2 Couplings.....	29
8.2 Regular Cleaning: Once a Month.....	30
8.2.1 Front Door.....	30
8.2.2 Air Regulator.....	30
8.3 Parts Replacement.....	31
8.3.1 Oil Absorbent Sheet.....	31
8.3.2 Oil Absorbent Pad.....	31
8.3.3 Door Oil Absorbent Sheet.....	31
8.3.4 Nozzle Skirt.....	32
8.3.5 Coupling O-rings.....	32
8.3.6 Spray Cans.....	32
9 Troubleshooting	33
10 Maintenance	34
10.1 Maintenance.....	34
10.2 Service.....	34
10.3 Consumables.....	35
11 Technical Specifications	36
11.1 Specifications.....	36
11.2 Intended User.....	37
11.3 Symbols.....	37
12 Electromagnetic Disturbances (EMD)	38

1 Accident Prevention

1.1 Customers

Make sure to obtain clear instructions concerning the various ways to use this device described in this accompanying manual.

Fill out and sign the warranty form and give the dealer from whom you purchased the device a copy.

1.2 Dealers

Be sure to give clear instructions concerning the various ways to use this device described in this accompanying manual.

After instructing the customer how to operate the device, have the customer fill out and sign the warranty form. Then fill in your own section of the warranty form and give the customer their copy. Be sure to send the manufacturer's copy to J. MORITA OFFICE.

1.3 Preventing Accidents

Most operation and maintenance problems result from insufficient attention to basic safety precautions and not being able to foresee potential accidents.

Problems and accidents are best avoided by anticipating potential dangers and operating the device in accordance with the manufacturer's recommendations. First, thoroughly read all precautions and instructions pertaining to safety and accident prevention. Then operate the device with the utmost caution to prevent either damaging the device itself or causing bodily injury.

If an accident occurs, the Lubrina 2 must not be used until repairs have been completed by a qualified and trained technician authorized by the manufacturer.

The following symbols and expressions indicate the degree of danger and harm that could result from ignoring the corresponding instructions:

WARNING

This alerts the user of the possibility of extremely serious injury or complete destruction of the device, as well as other property damage including the possibility of fire.

CAUTION

This alerts the user of the possibility of minor or moderate injury or damage to the device.

 This refers to mandatory actions and procedures that are required to prevent damage to the device.

The user (e.g., healthcare facility, clinic, hospital, etc.) is responsible for the management, maintenance and use of medical devices.

This device must not be used by anyone other than dentists, doctors, or other legally licensed professionals.

Do not use the Lubrina 2 for purposes other than lubrication and flushing as part of handpiece maintenance.

* The term "flushing", as used in this manual, means ejecting and removing cutting debris and foreign objects from inside the handpiece.

1.4 Disclaimers

- J. MORITA MFG. CORP. will not be responsible for accidents, product damage, or bodily injury resulting from:
 - (1) Repairs made by personnel not authorized by J. MORITA MFG. CORP.
 - (2) Any changes, modifications, or alterations of its products.
 - (3) The use of products made by other manufacturers, except for those procured by J. MORITA MFG. CORP.
 - (4) Maintenance or repairs using parts or components other than those specified by J. MORITA MFG. CORP. or other than in their original condition.
 - (5) Operating the device in a manner other than described in the operating procedures in this manual or in a manner inconsistent with the safety precautions and warnings in this manual.
 - (6) Workplace, environmental, or installation conditions that do not conform to those stated in this manual, such as an improper electrical power supply.
 - (7) Fires, earthquakes, floods, lightning, natural disasters, or forces majeure.
- J. MORITA MFG. CORP. will offer replacement parts and service for the product for a period of 10 years after the manufacturing of the product has been discontinued. Replacement parts and service will continue to be available during that period.
- The useful life of the Lubrina 2 is 5 years (based on self-certification) from the date of installation provided it is regularly and properly inspected and maintained.

2 Precautions

WARNING

- Do not modify the device.
- Do not place anything on top of the device.
- Do not use the device near open flames or any place where it will be subjected to high temperatures. Doing so could cause the spray cans installed to catch fire or explode.
- Never touch the power supply cord or Power Switch with a wet hand. There is a danger of an electric shock.
- In case of lightning, stop using the device immediately and do not touch the unit or connected power cord to avoid the risk of electric shock.
- The device must be installed and operated in a well-ventilated location.
- If you find any abnormality of the device (smoke, burning smell, etc.), turn the power off and disconnect the power cord plug from the power outlet immediately. Then contact your local dealer or J. MORITA OFFICE.
- To prevent infection, always wear appropriate personal protective equipment such as surgical gloves when using or cleaning the device.

IMPORTANT PRECAUTIONS

These precautions are especially critical for safe operation and use.

- Do not use the wireless transmission devices listed below in the patient examination area. Electromagnetic interference from such devices could cause the Lubrina 2 to malfunction. All devices which transmit electromagnetic waves in the examination area should be turned off.
 - (1) Mobile phones
 - (2) Wireless transmitting devices such as ham radios, walkie-talkies, and transceivers.
 - (3) Personal Handy-phone System (PHS)
 - (4) Routers for intra-building paging systems, wireless LANs, analog cordless telephones, and other electric wireless devices.
- Electromagnetic emissions produced by electric scalpels, lighting equipment, or other devices being used nearby could adversely affect the Lubrina 2 operation.
- The device cannot be used for air bearing handpieces (e.g., ASTRON series from J. MORITA).

CAUTION

- If the device will not be used for a while, unplug the power cord plug from power outlet and close the air supply valve.

Rx Only Prescription Device
CAUTION: Federal law restricts this device to sale by or on the order of a dentist.
(Valid only for U.S.A.)

3 Intended Use and Usage Flow

Intended Use

The Lubrina 2 is for lubricating and flushing debris and foreign objects from inside dental handpieces.

Usage Flow

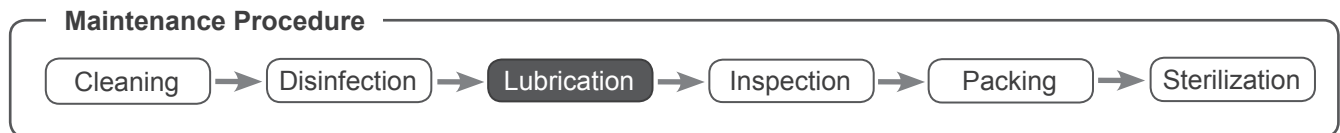

Lubrication



Handpieces can be lubricated using the Lubrina 2.

⚠ WARNING





- To prevent the spread of grave, life-threatening diseases like HIV and hepatitis B, be sure to autoclave handpieces after performing maintenance using the Lubrina 2.

4 Components

Main Unit

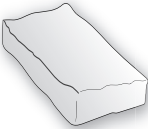
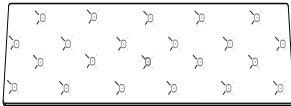
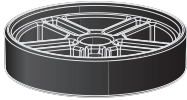

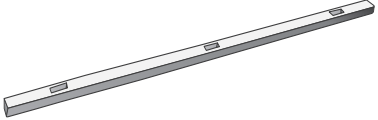
Accompanying Items (Parts of Device and Consumables)

<p>Oil Absorbent Pad (Qty: 1)</p>	<p>Oil Absorbent Sheet (Qty: 1)</p>	<p>Spray Stands (Qty: 2)</p>
		
<p>Power Cord (Qty: 1)</p>	<p>Air Tube (Qty: 1)</p>	<p>Door Oil Absorbent Sheet (Qty: 1)</p>
 <p>* Cord type and plug shape depend on your country or region.</p>		
<p>Front Door Sheet Stopper (Qty: 1)</p>		
		

5 Parts Identification and Function

5.1 Parts Identification

■ Front Side

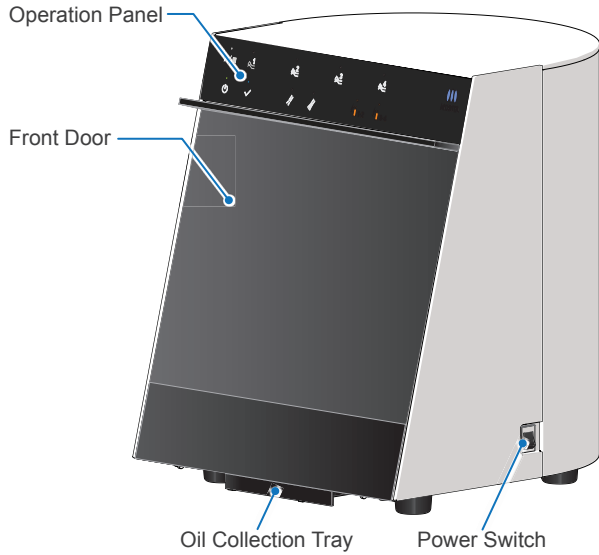

■ Front View

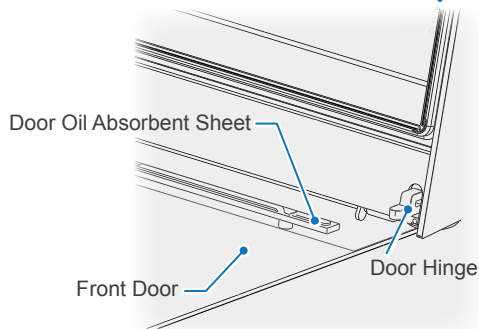
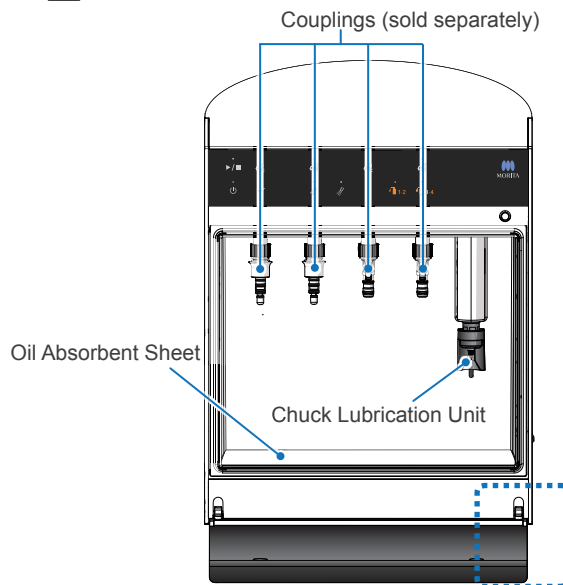

■ Rear View

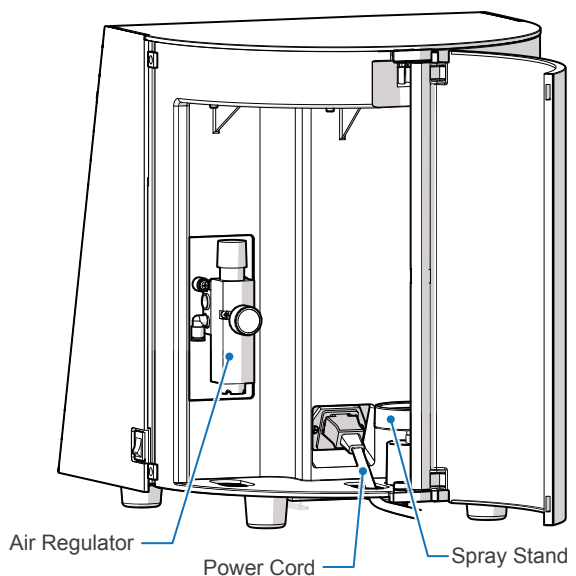
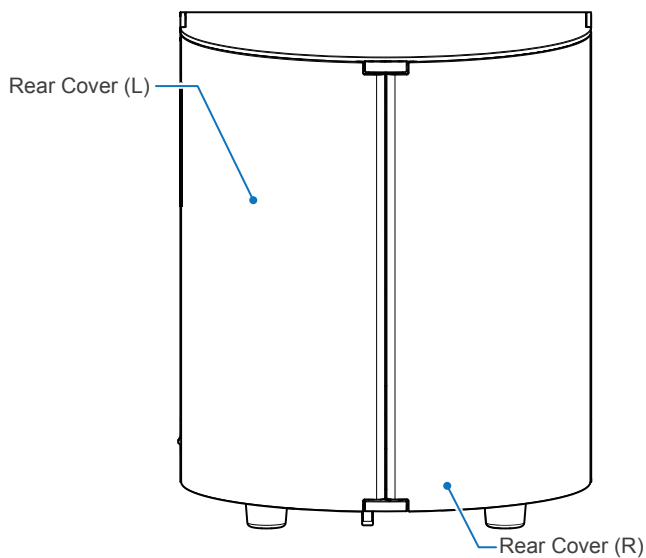

5.2 Operation Panel: Name and Function of Switches and Indicator Lamps

Switches

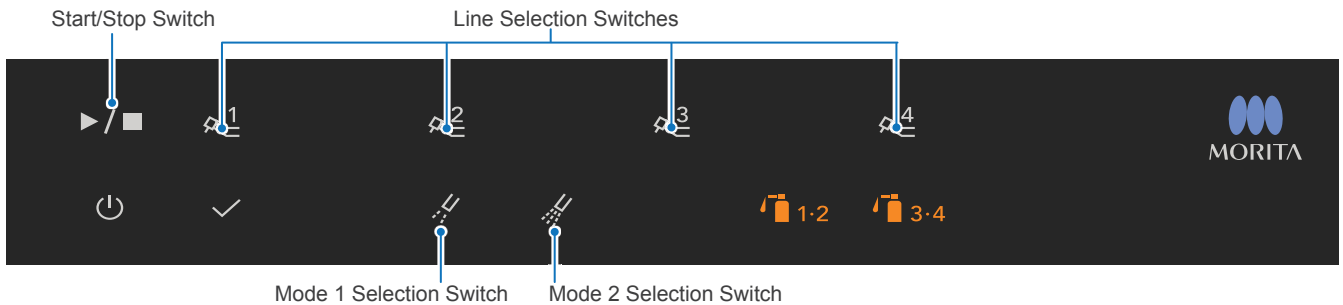

Start/Stop Switch



Press this switch to start or stop lubrication.

Line Selection Switches



Select desired line(s) from Line 1 through 4, for handpiece maintenance.

Mode 1 Selection Switch



Press this switch to select Mode 1 when connecting handpieces recommended for Mode 1.

Mode 2 Selection Switch



Press this switch to select Mode 2 when connecting handpieces recommended for Mode 2.

5.2.1 Recommended Mode

Depending on the type of handpiece, you can choose from two modes. Each mode has different settings for oil usage and blowing out (idle running) time.

The initial settings are Mode 1 for Lines 1 & 2, and Mode 2 for Lines 3 & 4. Use the chart below as a reference for changing the settings as necessary.

p. 26 "7.3.4 Switching Maintenance Mode"

Handpiece Type		Recommended Mode	
		Mode 1 (Operating Time: 20 sec/handpiece)	Mode 2 (Operating Time: 40 sec/handpiece)
Air Turbine Handpiece		✓	
Straight Handpiece			✓
Contra Angle Handpiece: Speed Reduction Model			✓
Contra Angle Handpiece: Constant Speed Model			✓
Contra Angle Handpiece: Speed Increasing Model			✓
Air Scaler	Air Solfy (J. MORITA product)	✓	
Air Motor	Air Torx (J. MORITA product)		✓
Endodontic Motor	Tri Auto ZX (J. MORITA product)		✓
	Tri Auto ZX2 (J. MORITA product)		✓
	Dentaport ZX (J. MORITA product)		✓
	Root ZX II (J. MORITA product)		✓
	Tri Auto mini (J. MORITA product)		✓

Always use Mode 2 for maintenance of speed increasing model contra angle handpieces. Using Mode 1 may result in a lack of lubricant.

* You can select and perform maintenance with Mode 2 for the handpieces recommended for Mode 1, but it may remain excess oil inside the handpiece when the maintenance is completed.

Indicator Lamps

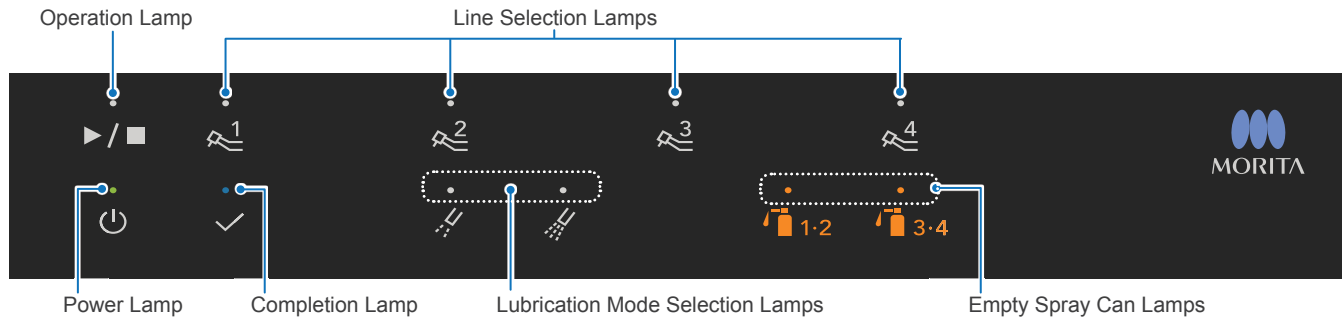

Power Lamp



This lights up when the Power Switch is turned on.

Completion Lamp



This lights up when handpiece lubrication is completed.

Lubrication Mode Selection Lamps



The corresponding lamps will light up based on the selected lines.

Operation Lamp



This lights up when handpiece lubrication is in progress.

Line Selection Lamps



Each lamp lights up when the corresponding line is selected. When performing the lubrication, the corresponding line lamp will blink.

When the front door opens during operation, all the line lamps will light up.

Empty Spray Can Lamps



Each lamp blinks if the corresponding line's air pressure does not reach the rated value.

[p.12 "6.1.2 Air Tube"](#)

Each lamp blinks when the corresponding spray can becomes empty during operation.

[p.16 "6.2.2 Spray Cans"](#)

Each lamp lights up when any abnormalities occur in the lubrication lines.

[p.33 "9 Troubleshooting"](#)

6 Setup

6.1 Main Unit

6.1.1 Installation

Install the main unit with at least the clearance shown below provided around the unit.

■ Front View

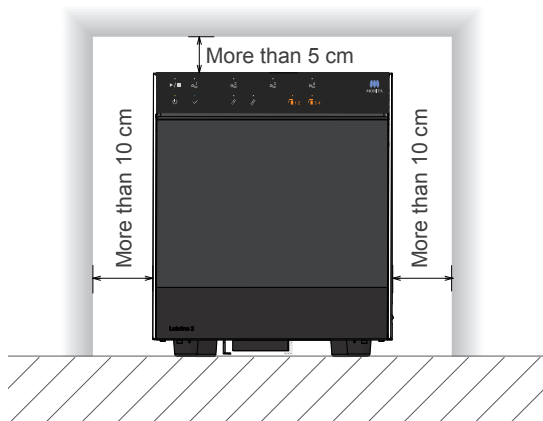

■ Top View

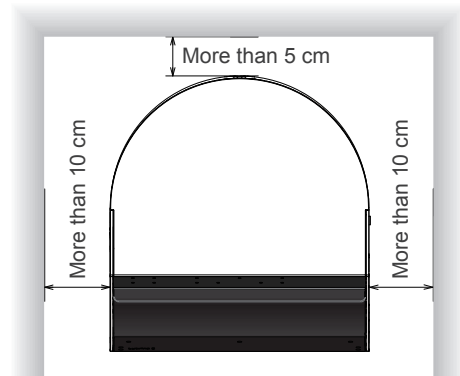

⚠ WARNING

- To prevent infection, always wear appropriate personal protective equipment such as surgical gloves, when using or cleaning the device. Then have the personal protective equipment disposed of appropriately.
- Do not use the device near open flames or any place where it will be subjected to high temperatures. Doing so could cause the spray cans installed to catch fire or explode.
- Install the main unit in a well-ventilated place and ventilate it regularly.

⚠ CAUTION

- Place the device on a level and stable surface. Otherwise, there is a risk of tipping over or falling.

! Make sure that the power cord and air tube are not under tension. Otherwise, it could cause a malfunction.

- * Provide sufficient space around the power outlet so that you can plug/unplug the power cord plug properly.

6.1.2 Air Tube

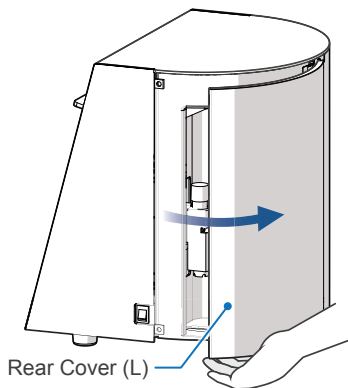
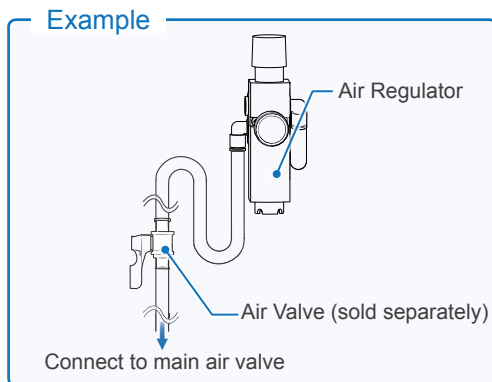

1. Open the rear cover (L).

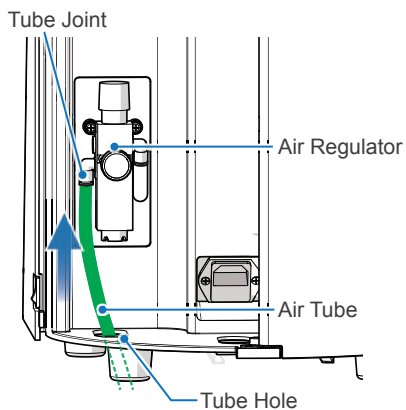

2. Pass the air tube through the tube hole and insert the tube into the tube joint firmly.
Connect the other end of the air tube to the main air valve.

- ⚠ Use compressed dry air that does not contain debris or oil. Otherwise, it could cause a malfunction.
- ⚠ Insert the air tube all the way into the tube joint. Otherwise, the air tube could be disconnected while air is supplied.
- ⚠ Use only the air tube that comes with the Lubrina 2. Any other tube might become disconnected unexpectedly.

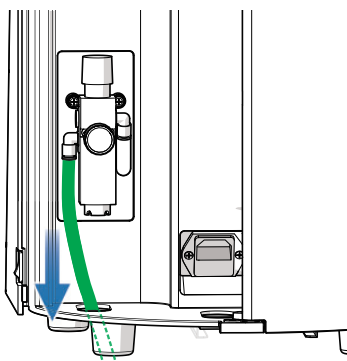

3. Give the air tube a light tug to make sure it is properly connected.
Then supply air by opening the main air valve.

- ⚠ Do not give the air tube a hard pull. Otherwise, the unit may tip over.
- ⚠ Make sure that the air tube is not bent or broken. Otherwise, it could cause a malfunction.

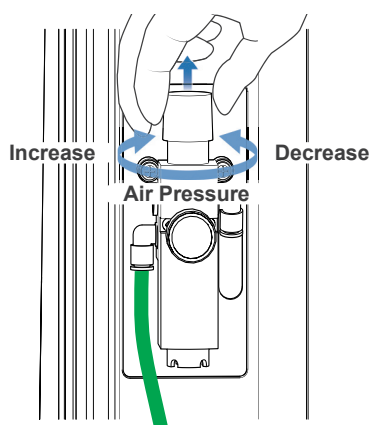

- Pull up the adjustment dial of the air regulator and then rotate it to adjust the air pressure between 0.3 MPa and 0.5 MPa.

* Recommendation: 0.4 MPa

⚠ WARNING

- Set the input air pressure at 0.7 MPa or less. Otherwise, there is a risk of bursting the air tube.

⚠ CAUTION

- Oil mist may occur depending on the type of handpieces and couplings. If so, lower the air pressure to 0.3 MPa.

- Do not set the air pressure less than 0.3 MPa. It could cause a malfunction.
- Do not set the air pressure more than 0.5 MPa. It also could causes a malfunction.

6.1.3 Power Cord

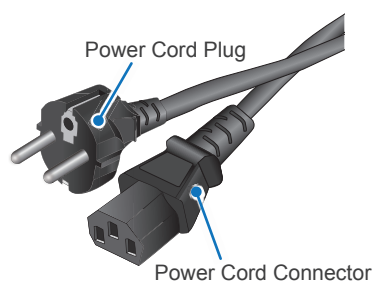

* Cord type and plug shape depend on your country or region.

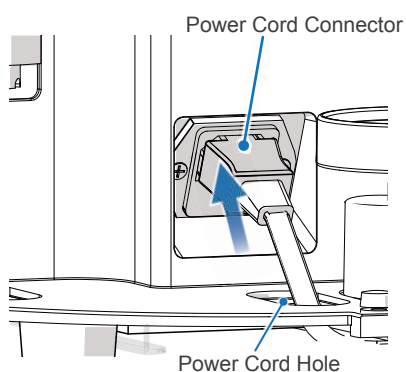

- Pass the power cord connector through the power cord hole and connect the connector.
- Plug the power cord plug into the power outlet.

⚠ WARNING

- Never touch the power cord with a wet hand. You could get an electric shock.
- Be sure to use the ground connection. Otherwise, there are risks of fire or electric shock if the Lubrina 2 malfunctions or electric leakage occurs.
- When connecting the power cord, connect the power cord connector to the unit first and then connect the power cord plug to the power outlet.

- Make sure the power cord connector is inserted all the way in. Otherwise, it could cause a malfunction.
- Hold the connector itself when you connect/disconnect the power cord. Holding the cord could cause a broken connection or a malfunction.

6.2 Spray Cans

■ Spray Cans and Lubrication Lines

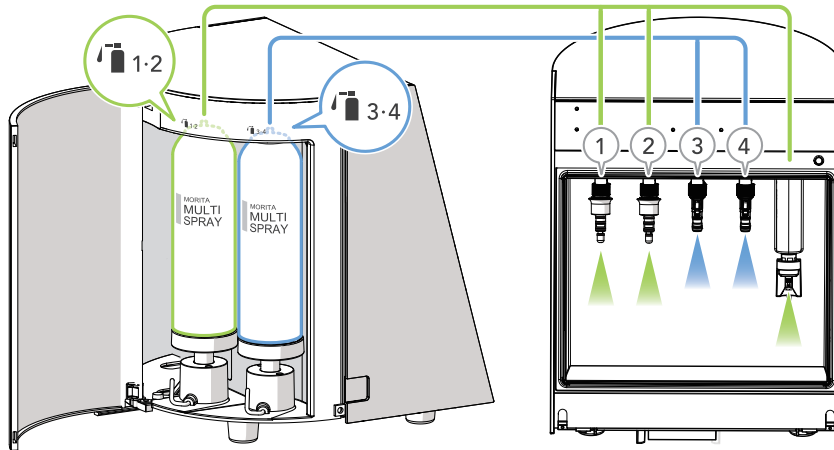

 1-2 Set the spray can for Lines 1 & 2, and the chuck lubrication unit.

 3-4 Set the spray can for Lines 3 & 4.

WARNING

- To prevent infection, always wear appropriate personal protective equipment such as surgical gloves, when using or cleaning the device.

■ Maintenance Spray

The Lubrina 2 can use J. MORITA's maintenance sprays^{*1} or designated maintenance sprays from other manufacturers^{*2}.

WARNING

- Never use maintenance sprays other than those designated by J. MORITA.
- Install the appropriate spray stand for each maintenance spray installed.

^{*1} J. MORITA's Maintenance Sprays: MORITA MULTI SPRAY, Universal Oil Spray

^{*2} Other manufacturers' maintenance sprays designated by J. MORITA:

Manufacturer	KaVo	NSK	YOSHIDA	W&H	Sirona	Bien-Air
Product Name	KaVo Spray**	NSK PANA SPRAY Plus**	YOSHIDA Spray**	W&H Service Oil F1**	Sirona T1 Spray**	LUBRIFLUID Spray**

■ Spray Stand

Spray stands provided with the Lubrina 2 can be used for J. MORITA's maintenance sprays^{*1} and other manufacturer's sprays^{*3} which have the same can shape.

^{*3} Maintenance sprays from other manufacturers that have the same can shape: W&H Service Oil F1**, etc.

For more details about usable spray types, adapted spray stands, and couplings, contact your local dealer or J. MORITA OFFICE.

** Trademarks or registered trademarks of the respective companies.

6.2.1 Spray Stands

Setting

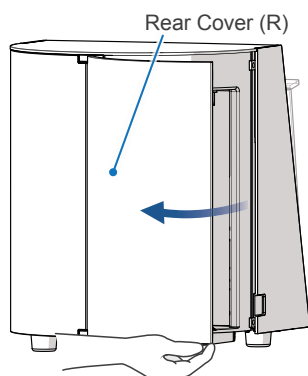

1. Open the rear cover (R).

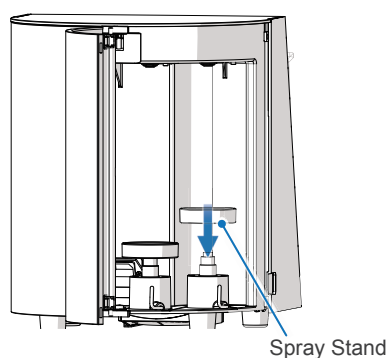

2. Make sure the top surface is facing up and then set it straight down.

Top Surface
(Facing Up)



Bottom Surface
(Facing Down)

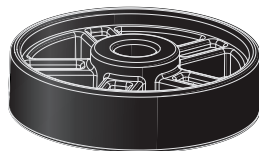

Removing

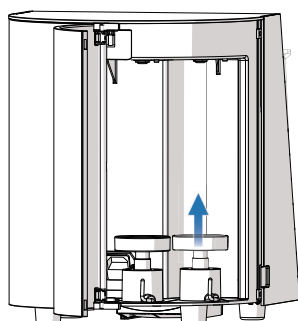

To replace the spray stand, remove the old stand by pulling it straight up and then install the new one by setting it straight down.

⚠ WARNING

- Use a spray stand corresponding to each spray can.

6.2.2 Spray Cans

Setting

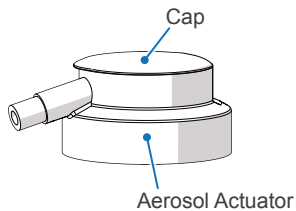

* Remove the cap and aerosol actuator from the spray can.

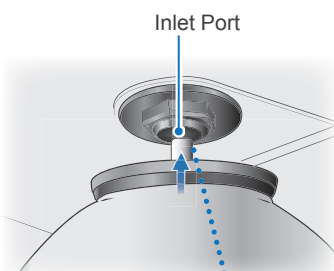

1. Open the rear cover (R), and then insert the tip of the spray valve stem into the inlet port.

⚠ CAUTION

- Do not press the tip of the spray valve stem with anything other than the inlet port. Otherwise, oil might spray out into your eyes.

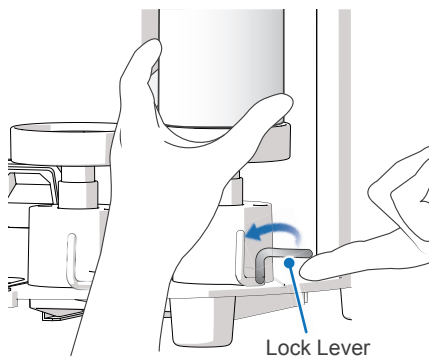
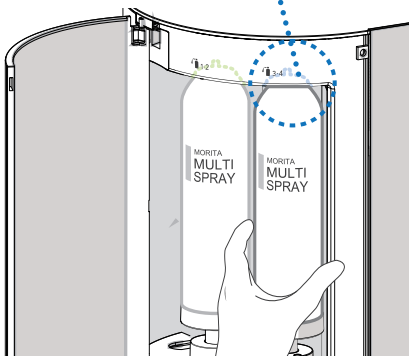

2. Hold the spray can with your hand and raise the lock lever in the counterclockwise direction.
Check that the spray can is not loose vertically.

* If it is loose, readjust it. 🖱 p. 17 "6.2.3 Spray Stand Adjustment"

⚠ CAUTION

- If a spray can is tilted or is otherwise not set correctly, oil might spray out into your eyes.

- ! Never use any cleaning sprays for air bearing handpieces (e.g., ASTRON CLEANER from J. MORITA). Doing so will damage the Lubrina 2 and handpieces.
- ! Make sure the lock levers are all the way up. Otherwise, improper connection results in not supplying oil. (The corresponding Empty Spray Can Lamp will light up.)

Removing

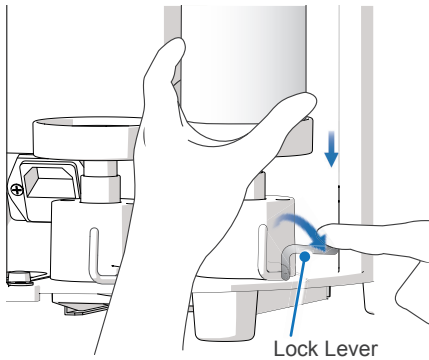

1. Turn the lock lever down in clockwise direction.
2. Check that the lock lever is horizontal, and then remove the spray can.

* If the spray can is still connected to the inlet port, pull the can straight down.

6.2.3 Spray Stand Adjustment

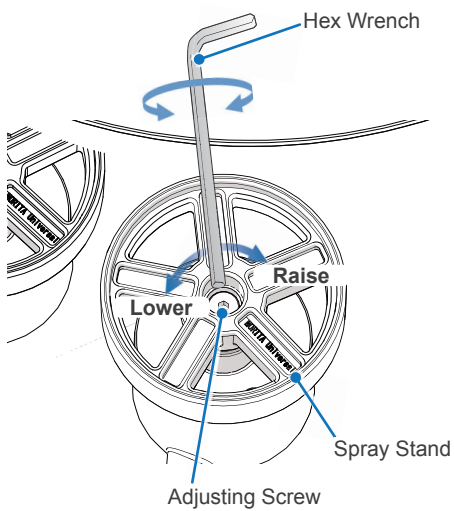

If the spray can is loose vertically even when the lock lever is properly raised, or if the lock lever cannot be raised, you need to remove the spray can and adjust the height of the spray stand.

To adjust the height, rotate the adjusting screw located in the center of the spray stand with a hex wrench.

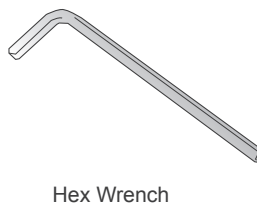

Hex Wrench

6.3 Couplings

Right

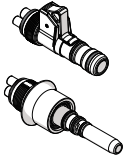

Lubrina 2
Couplings

Wrong

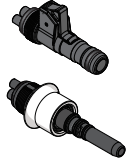

Lubrina
Couplings

Couplings for the Lubrina cannot be used for the Lubrina 2.

* The Tri Auto ZX coupling is an exception and is the only coupling that can be used universally.

⚠ CAUTION

- For handpieces from other manufacturers, use the optional couplings designed specifically for the Lubrina 2 or genuine couplings of your dental treatment unit.
- Do not use couplings made for other manufacturers' maintenance devices. Doing so could result in releasing oil mist or poor handpiece maintenance.

■ Attaching

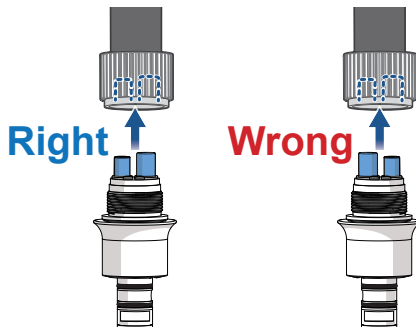

1. Open the front door and check that mode setting and coupling type are matched. Set the coupling's thick pipe to the right side and insert the coupling into the connector.

☞ p. 9 "5.2.1 Recommended Mode"

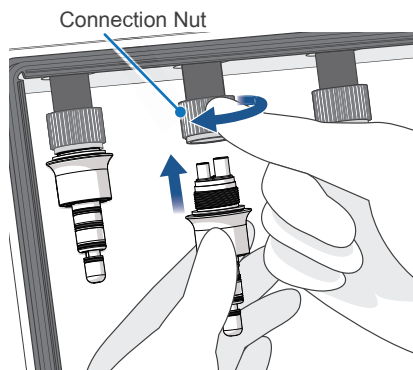

2. Push the coupling against the connector with one hand, and pull down the connection nut with the other hand and tighten it in the arrow direction shown in the illustration. Give a little jiggle to the coupling and check that it is securely connected.

⚠ Do not tighten the connection nut with pliers or other tools. This will damage the coupling.

* If you cannot tighten the connection nut smoothly, loosen it and try again.

* Tighten the connecting nut firmly by hand. Otherwise, oil and air will leak and the maintenance will not be properly performed.

■ Removing

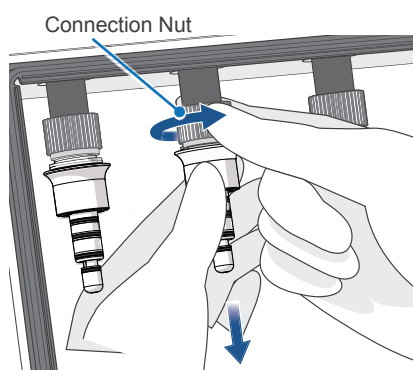

Push the coupling against the connector with one hand, and loosen the connection nut with the other hand in the arrow direction shown in the illustration.

6.4 Oil Absorbent Sheet

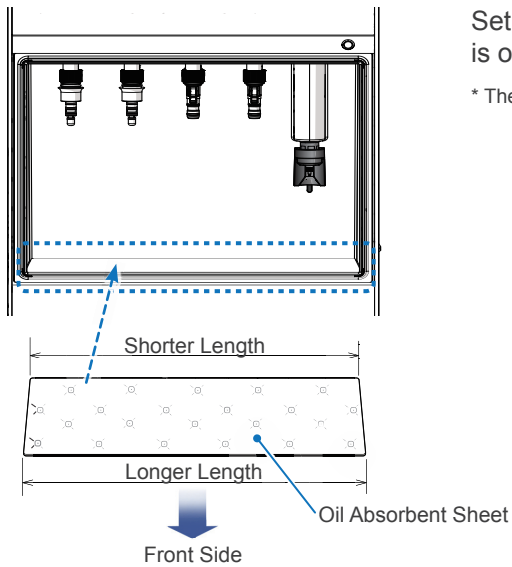

Set an oil absorbent sheet in the unit. Check that the longer direction is oriented towards the front side of the unit.

* The sheet can be installed either way up.

6.5 Oil Collection Tray and Oil Absorbent Pad

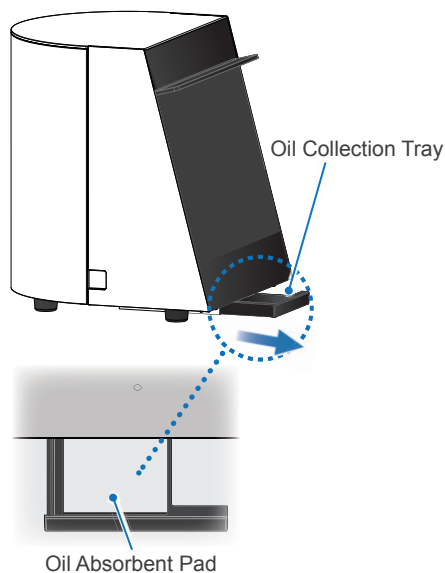

Pull out the oil collection tray, set an oil absorbent pad into it, and then put it back all the way in.

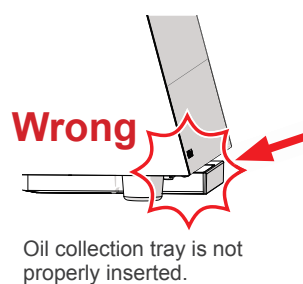
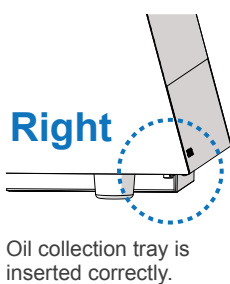

⚠ CAUTION

- Make sure that the oil collection tray is inserted all the way in. Otherwise, the front door cannot be closed properly and oil mist might spray out into your eyes.

6.6 Door Oil Absorbent Sheet and Front Door Sheet Stopper

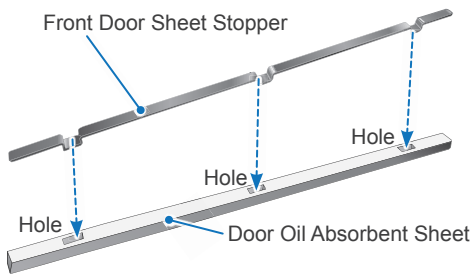

1. Insert the front door sheet stopper into the door oil absorbent sheet with the bumps on the front door sheet stopper aligned with the holes on the door oil absorbent sheet.

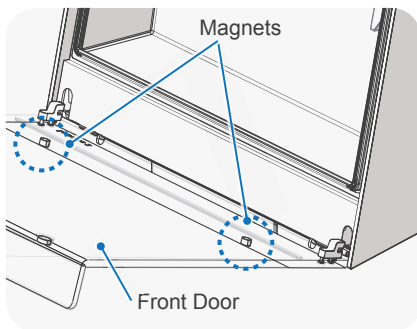
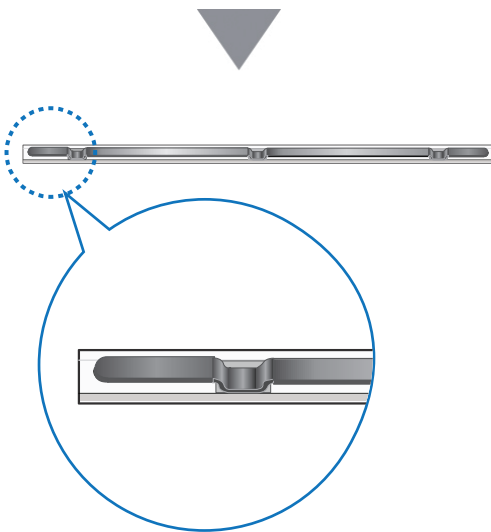

2. Line up the magnets from the front door with the metal bumps on the sheet stopper, so that the door oil absorbent sheet can be set in place.

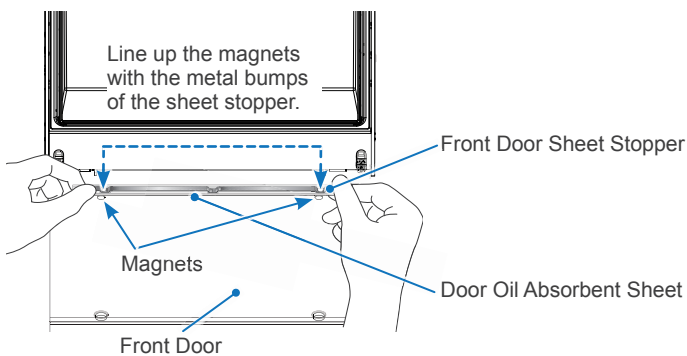

7 Usage

7.1 Operating, Transport and Storage Environments

Operating Environments:

Temperature: +10°C to +40°C (+50°F to +104°F)

Humidity: 30% to 75% (without condensation)

Atmospheric Pressure: 70 kPa to 106 kPa

- Do not expose the device to direct sunlight for an extended period of time.
- If the device has not been used for some time, make sure it works properly before using it again.

Transport and Storage Environments:

Temperature: -10°C to +50°C (+14°F to +122°F)

Humidity: 10% to 85% (without condensation)





Atmospheric Pressure: 70 kPa to 106 kPa

- Do not transport or store the device with spray cans installed.

7.2 Maintenance Categories

Maintenance categories for the Lubrina 2 are shown in the table below.

 p. 26 "7.3.4 Switching Maintenance Mode"

Maintenance Category	Purpose	Applications  p.9		Total Operating Time	Basic Operations
		Air Turbine Handpiece	Micromotor Attachment		
Chuck Lubrication (daily use)	Chuck maintenance performed before handpiece body lubrication.	✓	✓	Approx. 4 sec	 p. 22 "7.3.2 Chuck Lubrication"
Handpiece Body Lubrication (daily use)	Mode 1	✓		Approx. 20 sec/handpiece	 p. 23 "7.3.3 Handpiece Body Lubrication"
	Mode 2		✓	Approx. 40 sec/handpiece	
Flushing (as necessary)	When black colored oil comes from the handpiece.	✓	✓	Approx. 80 sec/handpiece	 p. 27 "7.4.2 Flushing Mode"
Air Blow (as necessary)	To remove water and excess oil inside the handpiece.	✓	✓	Approx. 30 sec/handpiece	 p. 27 "7.4.1 Air Blow Mode"

7.3 Basic Operation

Be sure to check the following points before using the Lubrina 2.

- Is the air pressure setting between 0.3 MPa and 0.5 MPa? (Recommendation: 0.4 MPa)
- Does each coupling have proper O-rings?
- Are all connection nuts for couplings properly secured?

7.3.1 Turning Power On/Off

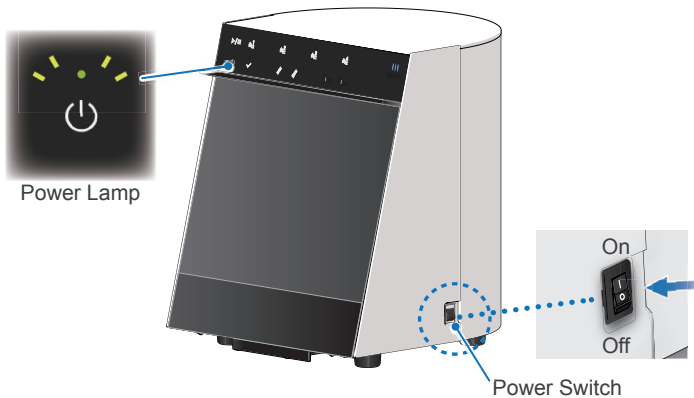

On the right side of the unit, turn the Power Switch on (|).

The Power Lamp lights up in green.

After use, turn the Power Switch off (○).

The Power Lamp will go out.

⚠ CAUTION

- Be sure to turn the Power Switch off after use.
- If the device will not be used for a while, unplug it and close the main air valve.

! If the device has not been used for some time, be sure to check that it works properly before using it again.

7.3.2 Chuck Lubrication

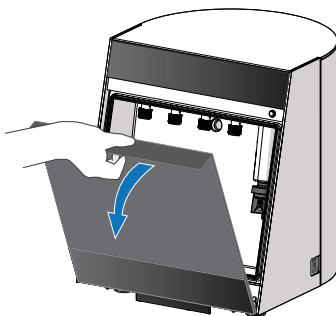

* Chuck lubrication is dedicated to air turbine handpieces and contra angle handpieces that use FG burs.

1. Open the front door.

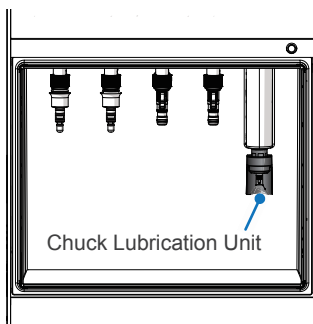

2. Line up the nozzle tip of the chuck lubrication unit with the handpiece bur insertion hole, and then insert the nozzle into the handpiece chuck.

Lift the handpiece straight up to start chuck lubrication.

Hold it up for approximately four seconds until you hear a single sustained beep.

If you hear a series of beeps instead of a single sustained beep, try again.

⚠ CAUTION

- Never move your face close to the unit during the chuck lubrication. Otherwise, oil might spray out into your eyes.

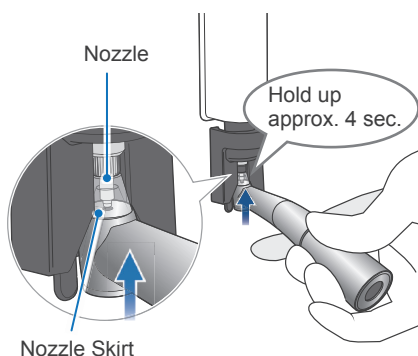

! Pay attention when lifting the handpiece up. Do not tilt the handpiece against the chuck nozzle. Doing so could damage the nozzle.

! If the handpiece is removed from the chuck nozzle before the single sustained beep, it may result in scattering a huge amount of oil.

! If the nozzle skirt comes off, be sure to reinstall it again. Otherwise, oil might spray out into your eyes.

☞ p. 32 "8.3.4 Nozzle Skirt"

7.3.3 Handpiece Body Lubrication

The initial settings are Mode 1 for Lines 1 & 2, and Mode 2 for Lines 3 & 4. Check the handpiece type and change the mode as necessary.

☞ p. 9 "5.2.1 Recommended Mode"

☞ p. 18 "6.3 Couplings"

☞ p. 26 "7.3.4 Switching Maintenance Mode"

1 Attaching Handpieces

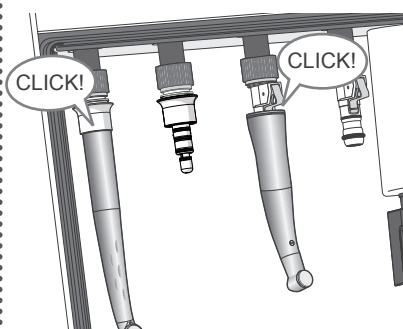
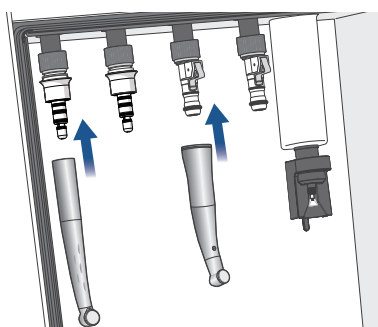

1. Attach handpieces to the coupling with the bur insertion hole facing toward the back. Insert the handpiece all the way in until you hear a clicking sound.

* If the bur insertion hole is facing toward the front, the front door will tend to get dirtier.

⚠ CAUTION

- Depending on the shape of handpiece and coupling, there could be a release of oil mist, which might spray out into your eyes. In that case, lower the pressure to 0.3 MPa.

☞ p. 12 "6.1.2 Air Tube"

- ! Insert the handpiece all the way in until it clicks into place. Otherwise, the handpiece could come off during the lubrication.

- ! If you find any damages on the coupling O-rings, replace them with new ones immediately. Otherwise, handpieces cannot be connected properly.

☞ p. 32 "8.3.5 Coupling O-rings"

- For micromotor attachments (straight or contra angle handpieces), some should have a bur inserted during lubrication and some should not. Refer to the user's manual that comes with the handpiece.

2. Give a little jiggle to the handpiece and check that it is securely connected.

3. Close the front door after attaching the handpieces to appropriate lines.

* Be sure to close the front door. Otherwise, the lubrication process will not start.

2 Starting Lubrication

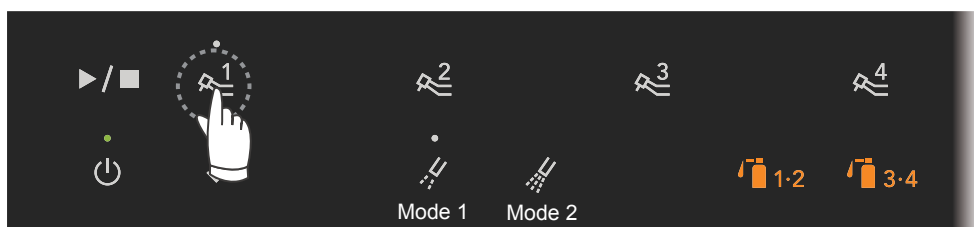

1. Press the desired Line Selection Switches for handpiece maintenance. The corresponding lamps will light up based on the selected lines. (Example: The illustration above shows that Mode 1 is selected for Line 1.)

To cancel the line selection, press the Line Selection Switch again. The Line Selection Lamp will go out.

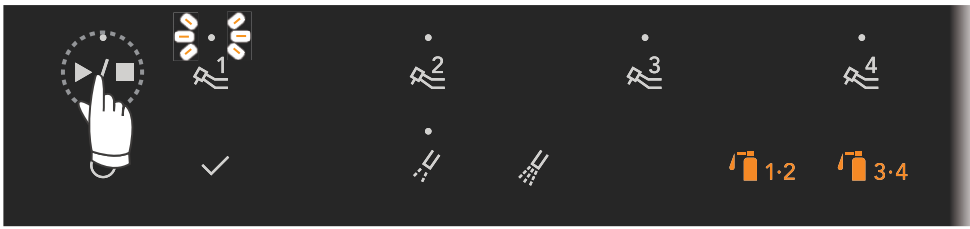

2. Press the Start/Stop Switch.

The Line Selection Lamp for the current lubrication process will blink, and the lamps for the reserved lines will light up.

Press the Start/Stop Switch again to stop the process.

⚠ CAUTION

- Do not press the Start/Stop Switch after selecting a Line that the handpiece is not connected. Otherwise, oil mist might spray out into your eyes.

⚠ Never remove the spray can during the operation. This will result in oil leakage and malfunction.

* Do not open the front door during lubrication. This will immediately stop the process.

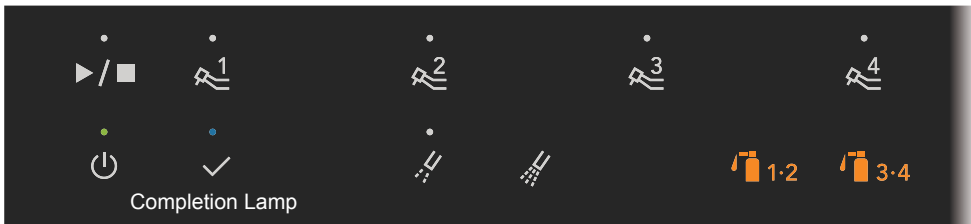

3. When lubrication for the all selected lines is completed, a single sustained beep will sound, and the completed Line Selection Lamps and Completion Lamp will light up.

* If you need to discharge excess oil: [☞ p. 27 "7.4.1 Air Blow Mode"](#)

3 Detaching Handpieces

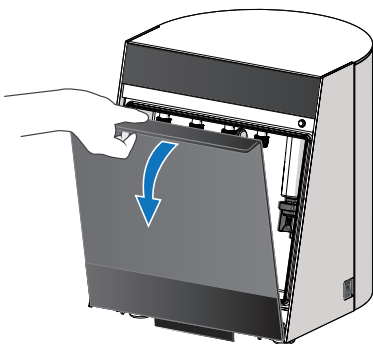

Check that the Completion Lamp is lit, and then open the front door.



Completion Lamp

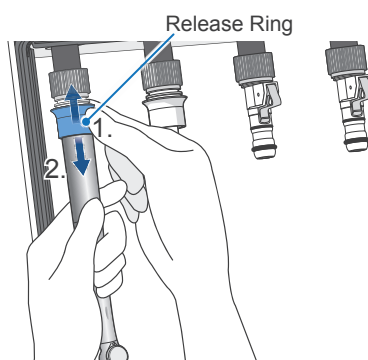

Air Turbine Handpieces

Hold the handpiece with one hand, push up the release ring with the other, and pull the handpiece out.

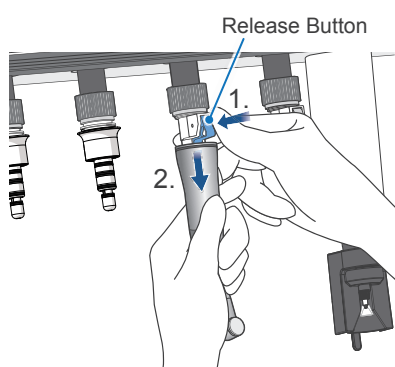

Micromotor Attachments

Hold the attachment with one hand, push the release button with the other, and pull the attachment out.

⚠ CAUTION

- Be careful not to injure your fingers from hitting them against the front door when detaching the handpieces.
- Wipe excess oil on the handpieces with a soft cloth or gauze, so as not to damage the handpiece surface.

4 Removing All Handpieces and Closing the Front Door

7.3.4 Switching Maintenance Mode

Mode 1/Mode2 Switching Procedures

The initial settings are Mode 1 for Lines 1 & 2, and Mode 2 for Lines 3 & 4. Check the handpiece type and select the most appropriate lubrication mode for each handpiece.

☞ p. 9 "5.2.1 Recommended Mode"

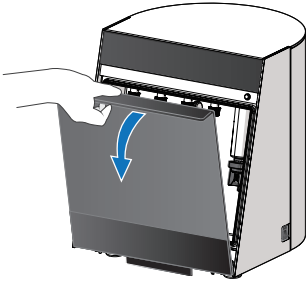

1. Turn the Power Switch on and then open the front door, so that switching operation will not cause the Lubrina 2 to malfunction.

Example: Change lubrication mode for Line 1 from Mode 1 to Mode 2.

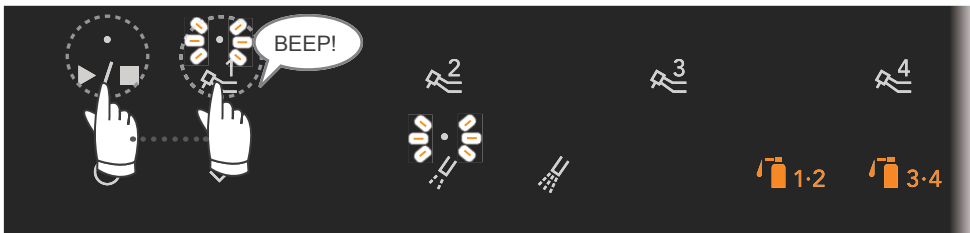

2. Hold down the desired Line Selection Switch and press the Start/Stop Switch for about two seconds until you hear a single sustained beep.
The Line Selection Lamp and currently set Lubrication Mode Selection Lamp will blink.

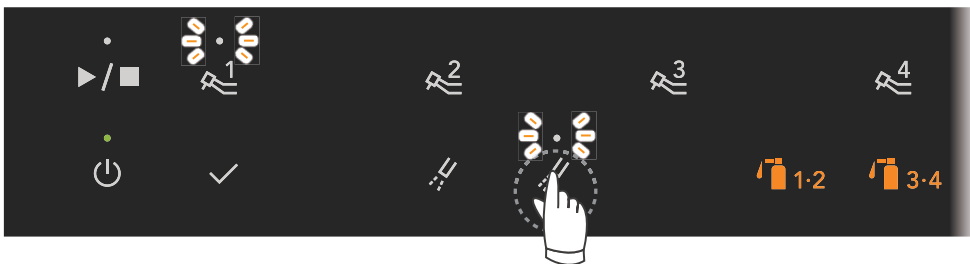

3. Press the desired Lubrication Mode Selection Switch.

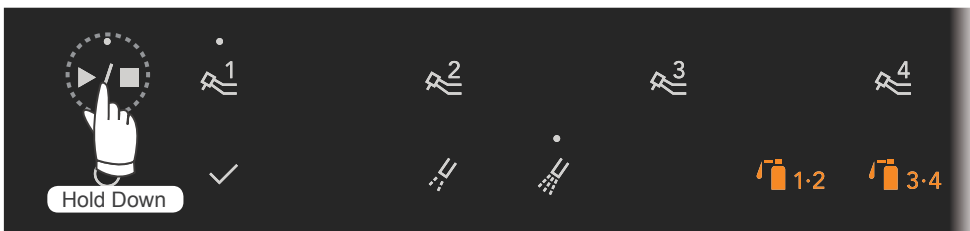

4. Hold down the Start/Stop Switch for about two seconds until you hear two short beeps.
The lamp will change from blinking to steady illumination which completes the setting process.

* The illustration above shows that Line 1 is set to Mode 2.

5. Turn the power off.

7.4 Other Maintenance Modes

7.4.1 Air Blow Mode

Use Air Blow Mode to remove excess oil when performing lubrication for handpieces other than J. MORITA products or after direct lubrication from a spray can.

■ Procedures

1. Attach the handpiece and close the front door.

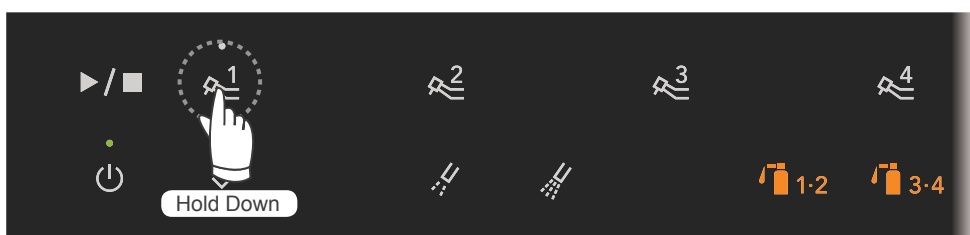

2. Hold down the Line Selection Switch for the line where the handpiece is attached.
Air Blow Mode starts after approximately two seconds. You can release the switch when the process starts. The process automatically stops after 30 seconds.
You can stop the process manually by pressing the Start/Stop Switch.

* Air Blow Mode can be set and performed on only one line at a time.

⚠ WARNING

- Always wear appropriate personal protective equipment such as surgical gloves, when using or cleaning the device.

7.4.2 Flushing Mode

Use Flushing Mode as needed, such as when black colored oil is discharged from the handpiece. Flushing Mode will set a longer time for lubrication and blowing air to boost the effectiveness of the flushing effect. Each handpiece requires approximately two minutes to complete the process.

* The term "flushing", as used in here shall mean ejecting and removing cutting debris and foreign objects from inside the handpiece.

⚠ CAUTION

- A large amount of oil mist is produced during Flushing Mode. Be sure to use Flushing Mode in a well-ventilated location.

Procedures

1. Attach the handpieces and close the front door.
2. Select the Line Selection Switches for the lines with the handpieces attached.

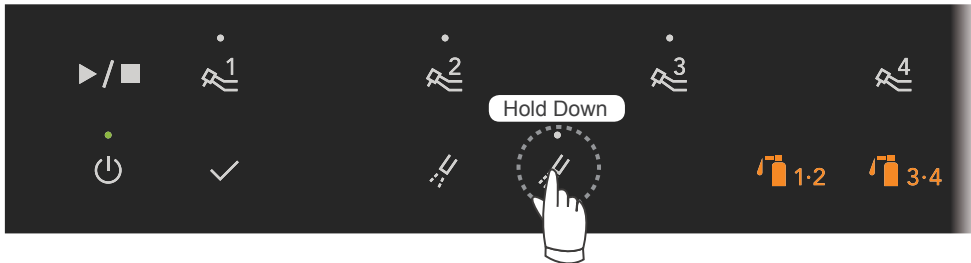

3. Check that the selected lines are correct, and then hold down the Mode 2 Switch for two seconds.

* The illustration above shows that Lines 1 through 3 are selected.

⚠ WARNING

- Always wear appropriate personal protective equipment such as surgical gloves, when using or cleaning the device.

⚠ CAUTION

- Be sure to check that the selected lines have handpieces connected. Otherwise, oil mist will be scattered.
- Be sure to use Flushing Mode where it is well-ventilated. Note that compared to Modes 1 and 2, more oil mist will be produced during Flushing Mode.

* Flushing Mode and Modes 1 or 2 cannot be set and performed at the same time.

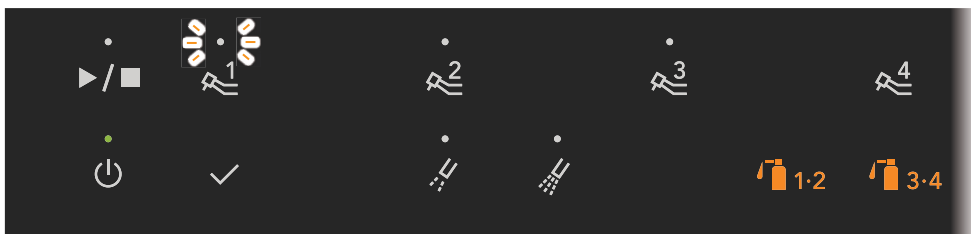

4. The Operation Lamp and both Mode Selection Lamps will light up while performing Flushing Mode. Also, the Line Selection Lamp blinks for the line currently being flushed.

* The illustration above shows that Line 1 is performing Flushing Mode.



5. When Flushing Mode is completed for the all selected lines, a single sustained beep will sound and the Line Selection Lamp for the completed line and the Completion Lamp will light up.

* Flushing Mode requires certain procedures. When Flushing Mode is completed, all lines will return to initial settings (Modes 1 or 2, or customized mode if you have changed settings).

* Wipe excess oil on the handpiece with a soft cloth or gauze, so as not to damage the handpiece surface.

8 Cleaning the Device and Replacing Parts

⚠ WARNING

- To prevent infection, always wear appropriate personal protective equipment such as surgical gloves, when using or cleaning the device.

⚠ CAUTION

- To prevent malfunction, be sure to turn the Power Switch off before performing the Lubrina 2 maintenance.

* Order parts from your local dealer or J. MORITA OFFICE.

8.1 Daily Cleaning

* Reinstall all parts after cleaning.

8.1.1 Main Unit

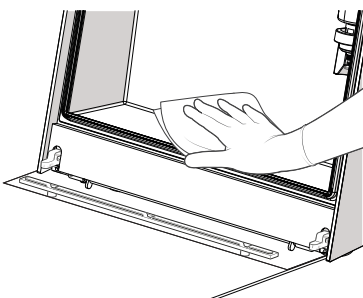

1. Remove the oil absorbent sheet, wipe off any remaining oil, and wipe off the unit with ethanol (70 vol% to 80 vol%).

☞ p. 19 "6.4 Oil Absorbent Sheet"

- ! Do not use disinfectants that contain chlorine-based cleaners or benzalkonium chlorinated aromatics. These solutions could discolor or damage plastic and corrode metal.
 - ! Be sure to use a soft cloth, such as gauze, to wipe off the unit. Otherwise, the unit surface will get scratched.
- * If there is dirt that is hard to remove, use a soft cloth with water and a little neutral detergent.

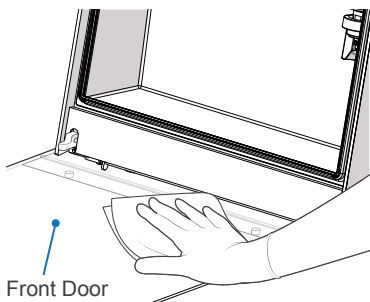

2. Remove the door oil absorbent sheet and front door sheet stopper, and clean the inside of the front door in the same way as the unit surface.

☞ p. 20 "6.6 Door Oil Absorbent Sheet and Front Door Sheet Stopper"

- ! Note that lack of cleaning will result in oil overflowing and contaminating the installation area.

8.1.2 Couplings

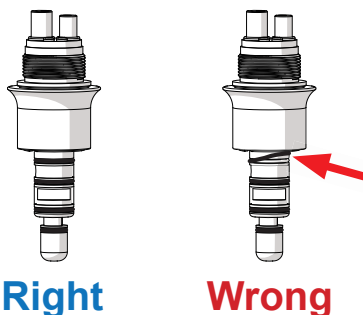

Clean the couplings with ethanol (70 vol% to 80 vol%).

Be sure to check that the O-rings are in place and not damaged.

If you find any damaged O-rings, replace them with new ones immediately.

☞ p. 32 "8.3.5 Coupling O-rings"

- ! Do not autoclave the couplings. Doing so could damage the couplings.
- ! Never attach a handpiece to a coupling if the O-ring is not properly in place. Doing so could result in improper lubrication, handpiece damage, or severing the O-ring, so that the handpiece becomes stuck and difficult to detach.
- ! Use a clean gauze to clean couplings. Debris inside the connection could cause the handpiece to malfunction.

* Be sure not to lose the O-rings.

8.2 Regular Cleaning: Once a Month

* Reinstall all parts after cleaning.

8.2.1 Front Door

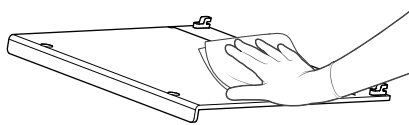
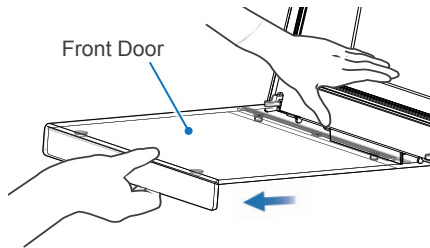

1. Open the front door and pull straight it out.

! Hold the device firmly with one hand and pull the front door straight out with the other hand. Do not apply excessive force or pull it out at an angle. This could damage the device.

2. Remove the door oil absorbent sheet and front door sheet stopper, and clean them with a neutral detergent.

Dry them naturally, or wipe off moisture with soft gauze.

! Do not use hot water. This could deform the plastic.

! Do not use a dryer. This could damage the front door. Always dry it naturally or use soft gauze to wipe off moisture.

3. Make sure the hinge direction is correct and replace the front door.

Graphic Explanation

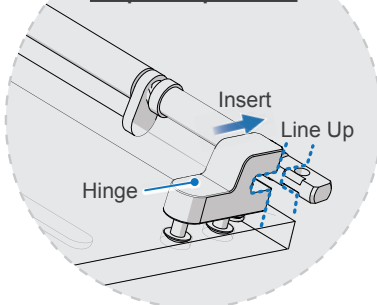

8.2.2 Air Regulator

Place a dry cloth underneath the air regulator and push up on the drain valve. Make sure that no water comes from the valve. If large quantities of water come out, there could be a problem with the air compressor and it may result in poor maintenance. Contact your local dealer or J. MORITA OFFICE.

☞ p. 12 "6.1.2 Air Tube"

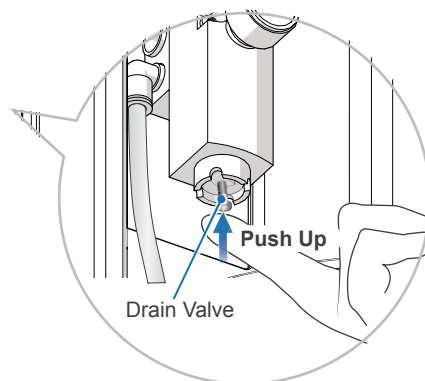
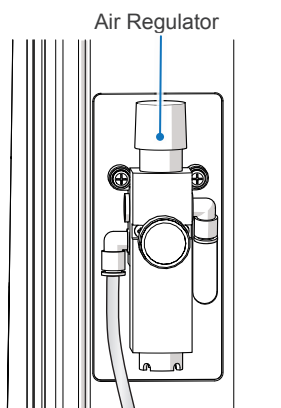

8.3 Parts Replacement

☞ p. 35 “10.3 Consumables”

- * Replace the parts as necessary depending on degree of wear and length of use.
- * Order parts from your local dealer or J. MORITA OFFICE.

8.3.1 Oil Absorbent Sheet

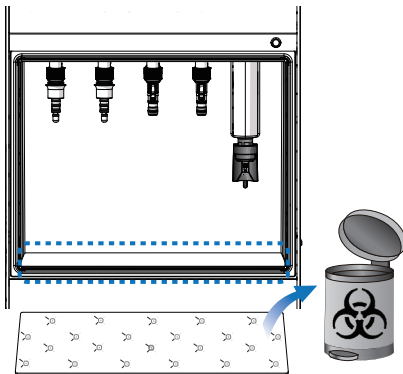

Remove the used oil absorbent sheet and replace it with a new one. Check that the sheet orientation is correct.

* A single sheet can absorb approximately one can of the MORITA MULTI SPRAY.

☞ p. 19 “6.4 Oil Absorbent Sheet”

⚠ CAUTION

- Dispose of used oil absorbent sheets according to regulations for medical waste.

- ! Always check the absorbed amount when performing the daily maintenance. Use of a sheet with excessive absorption could result in oil overflowing from the device.

8.3.2 Oil Absorbent Pad

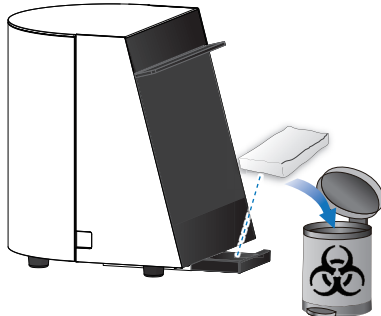

Pull out the oil collection tray from the bottom of the device.

Remove the used oil absorbent pad and replace it with a new one.

☞ p. 19 “6.5 Oil Collection Tray and Oil Absorbent Pad”

⚠ CAUTION

- Dispose of used oil absorbent pads according to regulations for medical waste.
- Do not use a pad with excessive oil absorption. Doing so could cause more oil mist to come out from the device and spray into your eyes.

8.3.3 Door Oil Absorbent Sheet

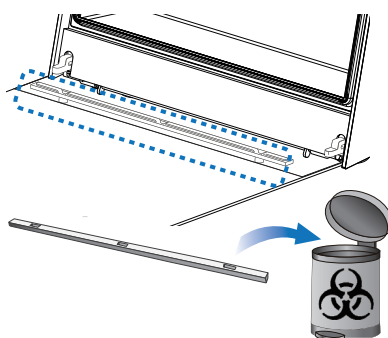

Remove the door oil absorbent sheet from the front door sheet stopper and replace the sheet with a new one.

☞ p. 20 “6.6 Door Oil Absorbent Sheet and Front Door Sheet Stopper”

⚠ CAUTION

- Dispose of used door oil absorbent sheets according to regulations for medical waste.

- ! Always check the absorbed amount when performing the daily maintenance. Use of a sheet with excessive oil absorption could result in oil overflowing from the device.

8.3.4 Nozzle Skirt

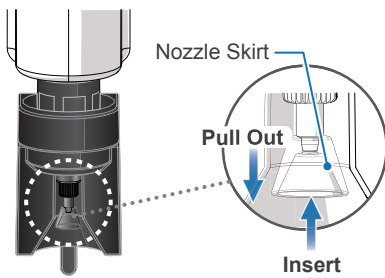

Turn the power off. Pull out the nozzle skirt and replace it with a new one. Make sure it is oriented the right way up, as shown in the illustration.

8.3.5 Coupling O-rings

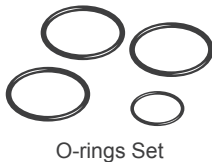
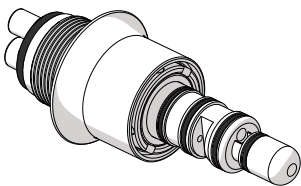

1. Remove the old O-rings with a pair of tweezers or another such tool.
2. Set the new O-rings according to coupling grooves.

* Use only O-rings that have been designed specifically for use with the coupling.

8.3.6 Spray Cans



Replace the can when the corresponding Empty Spray Can Lamp starts to blink.

☞ p. 16 "6.2.2 Spray Cans"

9 Troubleshooting

If the Lubrina 2 does not seem to be working properly, first inspect the locations described below.

* If you cannot inspect the device yourself or if the device fails to work properly after being adjusted or after parts are replaced, contact your local dealer or J. MORITA OFFICE.

Symptoms	Possible Causes	Remedies	Ref. Page
No power when the Power Switch is turned on.	The power cord is not properly plugged into the power outlet.	Connect the power cord correctly.	p. 13
	The power cord is not properly connected to the device.		
Cannot attach handpieces.	Coupling or handpiece connection is deformed.	Have the coupling or handpiece repaired.	N/A
	Debris on the coupling or handpiece connection. O-ring is dislocated.	Remove debris. Replace the O-ring with a new one.	pp. 29, 32
	Forcibly detached the handpiece without unlocking.	Pull up the release ring.	p. 25
Lubrication does not start when the Start/Stop Switch is pressed.	No line is selected.	Select at least one line before pressing the Start/Stop Switch.	p. 23
The device makes a small noise several times when pressing the Start/Stop Switch.	This is not a malfunction. The device may dispense oil more than once to stabilize the discharge amount when the spray can is nearly empty, etc.	N/A	N/A
Process stops immediately when pressing the Start/Stop Switch. <ul style="list-style-type: none"> ■ All Line Selection Lamps blink ■ A triple beep sounds 	The front door is open.	Close the front door properly and press the Start/Stop Switch again.	N/A
Process stops before lubrication. <ul style="list-style-type: none"> ■ Selected Line Selection Lamp and corresponding Empty Spray Can Lamp blink ■ A short series of beeps sounds 	Spray can is empty.	Replace the spray can with a new one.	p. 16
	Spray can is not properly installed.	Fix the spray can and spray stand installation.	pp. 15, 16
	Compressed air is not supplied.	Connect the air tube correctly.	p. 12
	Air regulator setting is not within the correct range.	Adjust the regulator and set the pressure within the specified range.	p. 12
	Air tube is bent.	Fix the air tube.	N/A
Cannot set a spray can.	Spray can is deformed.	Use only properly shaped spray cans.	N/A
Oil leaks from a spray can.	Spray stand is not properly adjusted.	Readjust the spray stand height.	p. 17
	Spray stand not designed for the spray can is used.	Replace the spray stand with the one that corresponds to the spray can.	p. 14
	Spray can not specified by J. MORITA is used.	Only use spray cans that are approved by J. MORITA.	p. 14
Odd odor from the device. The device gets unusually dirty.	Handpiece was not connected to the lubrication line.	Select only lines with handpieces connected.	p. 23
	Oil absorbent pad is saturated.	Remove the old pad, clean the device, and set a new oil absorbent pad.	pp. 19, 31
	Oil absorbent sheet is dirty.	Remove the old sheet, clean the device, and set a new oil absorbent sheet.	pp. 19, 31
	Spray can is not properly installed.	Fix the spray can and spray stand installation.	pp. 15, 16
	Air pressure is set out of specified range.	Adjust the regulator and set the pressure within the specified range.	p. 12
Oil mist is released. Installation surfaces get oily.	Handpiece shape	Depending on the type or shape of handpiece, there could be a release of oil mist. Reduce the air pressure to 0.3 MPa.	p. 12
	Air pressure setting is too high.	Adjust the regulator and set the pressure within the specified range.	p. 12
	No bur inserted in straight attachment.	Refer to the user's manual that comes with the handpiece. (For some handpieces, oil mist may be released if a bur is not inserted.)	N/A
Empty Spray Can Lamp stays on.		Something is wrong with oil supply lines inside the device. If the lamp still lights up even after performing maintenance again, have the device repaired.	N/A

10 Maintenance

10.1 Maintenance

■ Regular Inspection

The user (i.e., healthcare facility, clinic, hospital etc.) is responsible for the management, maintenance and use of medical devices.

- * The Lubrina 2 should be inspected every six months in accordance with the inspection items listed below.
- * Maintenance and inspection are generally considered to be the duty and obligation of the user, but if, for some reason, the user is unable to carry out those duties, the user may rely on qualified medical device service personnel. Contact your local dealer or J. MORITA OFFICE for details.
- * For repair or other types of service, contact your local dealer or J. MORITA OFFICE.

Maintenance Performed by the User:

- Switches: All switches should work correctly.

Maintenance Performed by Qualified Medical Device Service Personnel:

- Electrical Wirings

■ Standards and Procedures for Disposal of Medical Devices

Any medical devices which could possibly be contaminated must be first decontaminated by the responsible doctor or medical institution and then be disposed of by an agent licensed and qualified to handle standard industrial waste and industrial waste requiring special treatment.



This symbol indicates that the waste of electrical and electronic equipment must not be disposed as unsorted municipal waste and must be collected separately. Contact your local dealer or J. MORITA OFFICE for details.





10.2 Service

The Lubrina 2 may be repaired and serviced by:

- The technicians of J. MORITA's subsidiaries worldwide.
- Technicians employed by authorized J. MORITA dealers and specially trained by J. MORITA.
- Independent technicians specially trained and authorized by J. MORITA.

* For repair or other types of service, contact your local dealer or J. MORITA OFFICE.

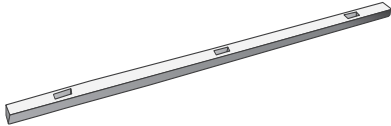
10.3 Consumables

<p>Oil Absorbent Pads (Qty: 5) Code No.: 7373465</p>	<p>Oil Absorbent Sheets (Qty: 5) Code No.: 7376847</p>	<p>Door Oil Absorbent Sheets (Qty: 5) Code No.: 7376839</p>
		
<p>Nozzle Skirt (Qty: 1) Code No.: 7373791</p>		
		

11 Technical Specifications

11.1 Specifications

* Specifications and appearance are subject to change without notice due to improvements.

Name	Lubrina 2
Model	HIM-2
Type	EX1: AC 120 V regions (e.g., North America) EX2: AC 230 V regions (e.g., CE) AS: Australia and New Zealand
Rating	AC 100 V to 240 V, 50/60 Hz
Power Consumption	10 VA to 25 VA
Fuse	250 V 2 A slow blow and high breaking type ø5 mm × 20 mm
Isolation from the Main Power Supply	Unplug the power cord from the main power supply.
Mode of Operation	Continuous operation
Maximum Input Air Pressure	0.7 MPa
Air Pressure	0.3 MPa to 0.5 MPa (Recommendation: 0.4 MPa)
Air Flow Rate	60 NL/min to 100 NL/min (0.3 MPa to 0.5 MPa)
Weight	Approx. 8 kg
Outer Dimensions	Width 300 mm x Depth 300 mm x Height 365 mm

Manufacturer: J. MORITA MFG. CORP.

■ Product Description

Used to maintain optimum performance and prolong useful life of dental handpieces.

Delivers oil and air automatically to handpiece.

Used after dental treatment and before autoclaving.

■ Operating Principle

Physical methods used to accomplish its intended use:

- Air Pressure: 0.3 MPa to 0.5 MPa
- Air Flow Rate: 60 NL/min to 100 NL/min
- Maintenance oil spray can

Mechanisms by which it works:























Operate the maintenance spray can to supply lubrication oil to the inside of the handpiece by discharging pressurized air into the spray can. Also, excess oil is removed from the handpiece by the pressurized air.

11.2 Intended User

- a) Engaged person (peoples) in dental clinic
- b) Language Understanding: English or other languages offered in the Instruction for Use.
Understanding of precautions and warnings.
- c) Experience: Not relevant

11.3 Symbols

* Some symbols may not be used.

	Manufacturer		Date of manufacture		Serial number
	GS1 DataMatrix		Power switch		Standby
	Oil mark		No open flame		General warning sign
	Warning; Flammable material		Refer to instructions for use		Ventilation required
	This way up		Keep away from rain		Fragile
	Temperature limitation		Humidity limitation		Atmospheric pressure limitation
Rx Only	Prescription Device CAUTION: Federal law restricts this device to sale by or on the order of a dentist. (Valid only for U.S.A.)		cTUVus certification mark (Valid only for U.S.A. and Canada)		CE marking Conforms with the European Directive, 93/42/EEC and 2011/65/EU
	Authorized representative in the European Community		Marking of electrical equipment in accordance with the European directive 2012/19/EU (WEEE)		

12 Electromagnetic Disturbances (EMD)

The Lubrina 2 (hereafter "this device") conforms to IEC 60601-1-2:2014 Ed. 4.0, the relevant international standard for electromagnetic disturbances (EMD).

The following is the "Guidance and Manufacturer's Declaration" which is required by IEC 60601-1-2:2014 Ed. 4.0, the relevant international standard for electromagnetic disturbances.

This is a Group 1, Class B product according to EN 55011 (CISPR 11).

This means that this device does not generate and/or use internationally radio-frequency energy, in the form of electromagnetic radiation, inductive and/or capacitive coupling, for the treatment of material or inspection/analysis purpose and that it is suitable for use in domestic establishments and in establishments directly connected to a low voltage power supply network which supplies buildings use for domestic purposes.

Guidance and Manufacturer's Declaration – Electromagnetic Emissions		
This device is intended for use in the electromagnetic environment specified below. The customer or the user of this device should assure that it is used in such an environment.		
Emissions Test	Compliance	Electromagnetic Environment – Guidance
Conducted disturbance CISPR 11	Group 1 Class B	This device uses RF energy only for its internal function. Therefore, its RF emissions are very low and are not likely to cause any interference in nearby electronic equipment. This device is suitable for use in all establishments, including domestic establishments and those directly connected to the public low-voltage power supply network that supplies buildings used for domestic purposes.
Radiated disturbance CISPR 11	Group 1 Class B	
Harmonic current IEC 61000-3-2	Class A	
Voltage fluctuations and flicker IEC 61000-3-3	Clause 5	

WARNING

- The use environment of this device is the Professional healthcare facility environment.
- This device needs special precautions regarding EMD and needs to be installed and put into service according to the EMD information provided in the ACCOMPANYING DOCUMENTS.
- Use of parts other than those accompanied or specified by J. MORITA MFG. CORP. could result in increased electromagnetic emissions or decreased electromagnetic immunity of this device and result in improper operation.
- Do not use this device as adjacent or stacked as possible with other. When adjoining or stacking is necessary, use it after observing whether this equipment and other equipment work properly.
- Portable and mobile RF communications equipment (including peripherals such as antenna cables and external antennas) should be used no closer than 30 cm to any part of the HIM-2, including cables specified by the manufacturer.

Guidance and Manufacturer's Declaration – Electromagnetic Immunity

This device is intended for use in the electromagnetic environment specified below.
The customer or the user of this device should assure that it is used in such an environment.

Immunity Test	IEC 60601 Test Level	Compliance Level	Electromagnetic Environment – Guidance
Electrostatic discharge (ESD) IEC 61000-4-2	±8 kV contact ±2 kV, ±4 kV, ±8 kV, ±15 kV air	±8 kV contact ±2 kV, ±4 kV, ±8 kV, ±15 kV air	Floors should be wood, concrete or ceramic tile. If floors are covered with synthetic material, the relative humidity should be at least 30%.
Electrical fast transients/bursts IEC 61000-4-4	±2 kV for power supply lines ±1 kV for input/output lines	±2 kV for power supply lines ±1 kV for input/output lines	Mains power quality should be that of a typical commercial or hospital environment.
Surge IEC 61000-4-5	<u>AC/DC power</u> ±0.5 kV, ±1 kV line(s) to line (s) ±0.5 kV, ±1 kV, ±2 kV line(s) to line(s) <u>Signal input/output</u> ±2 kV line(s) to earth	<u>AC/DC power</u> ±0.5 kV, ±1 kV line(s) to line(s) ±0.5 kV, ±1 kV, ±2 kV line(s) to earth <u>Signal input/output</u> ^{*1} ±2 kV line(s) to earth	Mains power quality should be that of a typical commercial or hospital environment.
Voltage dips, short interruptions and voltage variations on power supply lines IEC 61000-4-11	<u>dips</u> 0% U_T : 0.5 cycle (at 0, 45, 90, 135, 180, 225, 270, 315°) 0% U_T : 1 cycle (at 0°) 0% U_T : 25/30 cycles (at 0°) <u>short interruptions</u> 0% U_T : 250/300 cycles 250 (50 Hz)/300 (60 Hz)	<u>dips</u> 0% U_T : 0.5 cycle (at 0, 45, 90, 135, 180, 225, 270, 315°) 0% U_T : 1 cycle (at 0°) 0% U_T : 25/30 cycles (at 0°) <u>short interruptions</u> 0% U_T : 250/300 cycles 250 (50 Hz)/300 (60 Hz)	Mains power quality should be that of a typical commercial or hospital environment. If user of this device requires continued operation during power mains interruptions, it is recommended that this device be powered from an uninterruptible power supply or a battery.
Power frequency (50/60 Hz) magnetic field IEC 61000-4-8	30 A/m (r.m.s.) 50 Hz or 60 Hz	30 A/m (r.m.s.) 50 Hz or 60 Hz	Power frequency magnetic field should be at levels characteristic of a typical location in a typical commercial or hospital environment.

NOTE 1: U_T is the a.c. mains voltage prior to application of the test level.

NOTE 2: r.m.s.: root mean square

*1: Not applicable because it does not connect directly to outdoor cable.

Guidance and Manufacturer's Declaration – Electromagnetic Immunity			
This device is intended for use in the electromagnetic environment specified below. The customer or the user of this device should assure that it is used in such an environment.			
Immunity Test	IEC 60601 Test Level	Compliance Level	Electromagnetic Environment – Guidance
Conducted RF IEC 61000-4-6	3 V	3 V	Portable and mobile RF communications equipment should be used no closer to any part of this device, including cables, than the recommended separation distance calculated from the equation applicable to the frequency of the transmitter.
	150 kHz – 80 MHz ISM ^(c) frequency band: 6 V	150 kHz to 80 MHz ISM ^(c) frequency band: 6 V	
Radiated RF IEC 61000-4-3	3 V/m	3 V/m	<p>Recommended separation distances</p> $d = 1.2 \sqrt{P} \quad 150 \text{ kHz to } 80 \text{ MHz}$ $d = 1.2 \sqrt{P} \quad 80 \text{ MHz to } 800 \text{ MHz}$ $d = 2.3 \sqrt{P} \quad 800 \text{ MHz to } 2.7 \text{ GHz}$ $d = \frac{6}{E} \sqrt{P} \quad \text{Portable wireless RF communication equipment}$ <p>Where P is the maximum output power rating of the transmitter in watts (W) according to the transmitter manufacturer, E is the compliance level in V/m and d is the recommended separation distance in meters (m).</p> <p>Field strengths from field RF transmitters, as determined by an electromagnetic site survey^(a), should be less than the compliance level in each frequency range^(b).</p> <p>Interference may occur in the vicinity of equipment marked with the following symbol:</p> 
	80 MHz to 2.7 GHz	80 MHz to 2.7 GHz	
	27 V/m	27 V/m	
	385 MHz	385 MHz	
	28 V/m	28 V/m	
	450 MHz	450 MHz	
	9 V/m	9 V/m	
	710, 745, 780 MHz	710, 745, 780 MHz	
28 V/m	28 V/m	Field strengths from field RF transmitters, as determined by an electromagnetic site survey ^(a) , should be less than the compliance level in each frequency range ^(b) .	
810, 870, 930 MHz	810, 870, 930 MHz		
28 V/m	28 V/m	Interference may occur in the vicinity of equipment marked with the following symbol:	
1720, 1845, 1970 MHz	1720, 1845, 1970 MHz		
28 V/m	28 V/m	Interference may occur in the vicinity of equipment marked with the following symbol:	
2450 MHz	2450 MHz		
9 V/m	9 V/m	Interference may occur in the vicinity of equipment marked with the following symbol:	
5240, 5500, 5785 MHz	5240, 5500, 5785 MHz		
NOTE 1: At 80 MHz and 800 MHz, the higher frequency range applies.			
NOTE 2: These guidelines may not apply in all situations. Electromagnetic propagation is affected by absorption and reflection from structures, objects and people.			
<p>(a) Field strengths from fixed transmitters, such as base stations for ratio (cellular/cordless) telephones and land mobile radios, amateur radio, AM and FM radio broadcast and TV broadcast cannot be predicated theoretically with accuracy. To assess the electromagnetic environment due to fixed RF transmitters, an electromagnetic site survey should be considered. If the measured field strength in the location in which this device is used exceeds the applicable RF compliance level above, this device should be observed to verify normal operation. If abnormal performance is observed, additional measures may be necessary, such as reorienting or relocating this device.</p> <p>(b) Over the frequency range 150 kHz to 80 MHz, field strengths should be less than 3 V/m.</p> <p>(c) The ISM (Industrial, Scientific and Medical) bands between 0.15 MHz and 80 MHz are 6.765 MHz to 6.795 MHz; 13.553 MHz to 13.567 MHz; 26.957 MHz to 27.283 MHz; and 40.66 MHz to 40.70 MHz.</p>			

■ Essential Performance

None

■ Cable Length

No.	Interface(s):	Max. Cable Length, Shielding	Cable Classification
1.	AC Power Cable	2.3 m (3-wire), Un-shielded	AC Power Line



Development and Manufacturing

J. MORITA MFG. CORP.

680 Higashihama Minami-cho, Fushimi-ku, Kyoto 612-8533, Japan
T +81. (0)75. 611 2141, F +81. (0)75. 622 4595

Morita Global Website
www.morita.com

Distribution

J. MORITA CORP.

3-33-18 Tarumi-cho, Suita-shi, Osaka 564-8650, Japan
T +81. (0)6. 6380 1521, F +81. (0)6. 6380 0585

J. MORITA USA, INC.

9 Mason, Irvine CA 92618, USA
T +1. 949. 581 9600, F +1. 949. 581 8811

J. MORITA EUROPE GMBH

Justus-von-Liebig-Strasse 27a, 63128 Dietzenbach, Germany
T +49. (0)6074. 836 0, F +49. (0)6074. 836 299

MORITA DENTAL ASIA PTE. LTD.

150 Kampong Ampat #06-01A KA Centre, Singapore 368324
T +65. 6779. 4795, F +65. 6777. 2279

J. MORITA CORP. AUSTRALIA & NEW ZEALAND

Suite 2.05, 247 Coward Street, Mascot NSW 2020, Australia
T +61. (0)2. 9667 3555, F +61. (0)2. 9667 3577

J. MORITA CORP. MIDDLE EAST

4 Tag Al Roasaa, Apartment 902, Saba Pacha 21311 Alexandria, Egypt
T +20. (0)3. 58 222 94, F +20. (0)3. 58 222 96

J. MORITA CORP. INDIA

Filix Office No.908, L.B.S. Marg, Opp. Asian Paints, Bhandup (West), Mumbai 400078, India
T +91-22-2595-3482

J. MORITA MFG. CORP. INDONESIA

28F, DBS Bank Tower, Jl. Prof. Dr. Satrio Kav. 3-5, Jakarta 12940, Indonesia
T +62-21-2988-8332, F + 62-21-2988-8201

SIAMDENT CO., LTD.

71/10 Mu 5, Thakham, Bangpakong, Chachuengsao 24130, Thailand
T +66. 38. 573042, F +66. 38. 573043
www.siamdent.com

EU Authorized Representative under the European Directive 93/42/EEC



MEDICAL TECHNOLOGY PROMEDT CONSULTING GmbH

Altenhofstraße 80, 66386 St. Ingbert, Germany T +49. 6894 581020, F +49. 6894 581021

The authority granted to the authorized representative, MEDICAL TECHNOLOGY PROMEDT Consulting GmbH, by J. MORITA MFG. CORP. is solely limited to the work of the authorized representative with the requirements of the European Directive 93/42/EEC for product registration and incident report.



Diagnostic and Imaging Equipment

Treatment Units

Handpieces and Instruments

Endodontic System

Laser Equipment

Laboratory Devices

Educational and Training Systems

Auxiliaries